

Linear

# MIMI SL R020 Fixture Guide

# KKDÖ

Outdoor | Surface | Output up to 1463lm/m (446lm/ft)



## Key applications

- ✓ Architectural detail
- ✓ Bathrooms
- ✓ Building facades
- ✓ Cabinet & furniture
- ✓ Cove lighting
- ✓ Direct lighting
- ✓ Exterior
- ✓ Hand rail
- ✓ Interior
- ✓ Mirror back lighting
- ✓ Retail display
- ✓ Shelving display
- ✓ Wet area

## Key features

- ✓ Adjustable
- ✓ Custom lengths
- ✓ Constant Voltage (CV)
- ✓ Diffusion: spoting
- ✓ Direct view
- ✓ Extensive CCT range
- ✓ Illuminated ends
- ✓ IP40 dry area
- ✓ IP67 waterproof
- ✓ Light on time (10 day delivery)
- ✓ Thin light line

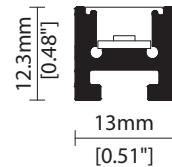

## MOUNTING METHODS



KKCP-02 Clip



KKBK-06 Fixed bracket



KKBK-05 Adjustable bracket

Linear

# MIMI SL R020

## Specification sheet



<b>Dimensions</b>	H12.3/W13/L99-2016mm (H0.48/W0.51/L3.89-79.37in)
<b>PCB Cut-point</b>	41.7mm increment/2000mm max (1.64in increment/78.74in max)
<b>LED Pitch</b>	6.95mm-144LED/m (0.27in - 44LED/ft)
<b>Chip</b>	<b>s-line</b> <b>k-line</b>
<b>Cover/Optics</b>	Clear silicone (110°)
<b>CCT</b>	<b>s-line:</b> 2300K/2500K/3000K/3400K/4000K <b>k-line:</b> 2300K/2500K/3000K/3400K/4000K
<b>LED binning</b>	<b>s-line:</b> 2-step MacAdam ellipse <b>k-line:</b> 3-step MacAdam ellipse
<b>CRI</b>	≥ 89
<b>Lifetime</b>	50,000 hours @ 25°C (50,000 hours @ 77°F)
<b>Operating temp</b>	T <sub>a</sub> = -25 to 45°C (T <sub>c</sub> max = 78°C) T <sub>a</sub> = -13 to 113°F (T <sub>c</sub> max = 172°F)
<b>IP Rating</b>	IP67
<b>Finish</b>	Silver anodised
<b>Mounting</b>	Surface mounting via clips or brackets
<b>Power feed</b>	Sheathed hardwire tails or male/female connectors
<b>Control</b>	0-10V/1-10V/DMX/DALI



### LED Grading Key

#### Exclusive Grade

<b>s</b> s-line*	*KKDC tuned CCT range
2-step CCT range	

#### Base Grade

<b>k</b> k-line	3-step commercial range Energy Star CCTs
-----------------	---

<b>Power consumption</b>	<b>Supply voltage</b>	<b>Supply current</b>
20W/m (6.10W/ft)	24V DC	0.83A/m (0.25A/ft)

### Performance Data (3000K)

	R1	R2	R3	R4	R5	R6	R7	R8	R9	R10	R11	R12	R13	R14
<b>k-line</b>	89	92	95	89	88	89	93	80	51	82	89	68	89	96

	<b>Clear</b>											<b>CRI</b>	<b>R9</b>	<b>Rf</b>	<b>Rg</b>
<b>s-line</b>	1463lm/m (446lm/ft) 73.1lm/W											93	64	-	-
<b>k-line</b>	1380lm/m (421lm/ft) 69lm/W											92	63	-	-

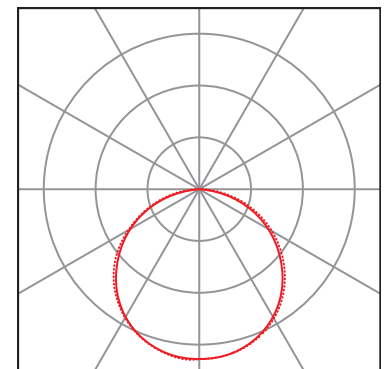
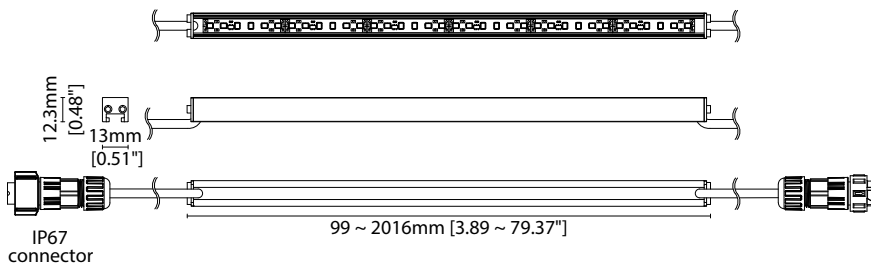

— C0 / C180    cd / 1000 lm    ..... C90 / C270

Data derived from independent UKAS/IESNA LM-79-08 accredited testing of production samples.

### FIXTURE

Model	Finish	Cover <sup>1</sup>	Grade <sup>2</sup>	LED	Colour (CCT) <sup>3</sup>	Length Availability <sup>4</sup>	IP	Cable Length	Power Feed <sup>5</sup>	Input
MIMI SL	SL Silver Anodised	SA No cover	X s s k k	R020 R020	2300K (2100K PCB) 23 3000K (2500K PCB) 30 3400K (2700K PCB) 34 4000K (3000K PCB) 40	m 99.3-2016mm 83.3mm increments  i 3.91-79.37in 3.28in increments  (Specify length code OR total run length)	IP67 67	300mm/ 11.81" 0300	Single ø4.3mm sheath tail S00A  Double ø4.3mm sheath tail D00A  Single ø4.3mm sheath IP67 connector S67A  Double ø4.3mm sheath IP67 connector D67A	DC 24V g

<sup>1</sup> Refer to **Cover/Lens Options** on **Options** pages

<sup>2</sup> Refer to **LED Grading Key** on **Specification sheet** page

<sup>3</sup> Actual colour temperature after colour shift caused by silicone potting

<sup>4</sup> Refer to **Length Availability List** or enter total run length instead of length code

<sup>5</sup> Refer to **Power feed Options** on **Options** pages

### Code Example:

SL	-	SA	-	X	-	s	-	R020	-	40	-	m	516	-	67	-	c	-	D67A	-	g		
MIMI SL		Silver Anodised		No cover		s		R020		4000K (3000K PCB)		m	516mm		IP67		c		300mm/11.81"		Double ø4.3mm sheath IP67 connector		DC 24V

### ACCESSORIES

#### Mounting Accessories

KKCP-02	Clip (1no.)
KKCP-52	Clip (500no.)
KKBK-06	Fixed bracket
KKBK-05	Adjustable bracket

\* Refer to **Mounting accessories** on **Accessories** pages

#### Connection Accessories

CN67-2P-0300	IP67 2 PIN male & female 300mm/11.81" pair
CN67-2P-1000	IP67 2 PIN male & female 1000mm/39.37" pair
CN67-2P-3000	IP67 2 PIN male & female 3000mm/118.11" pair

\* Refer to **Power feed** on **Accessories** pages

#### Exterior Junction Boxes

KKJB-07	IP67 Slim J-Box
KKJB-07R	Potting Resin for IP67 Slim J-Box

\* Refer to **Exterior Junction Boxes** on **Accessories** pages

#### PSU/Driver

0-10V/1-10V/DALI/DMX

\* Refer to **Driver/PSU Options** page for details or provide requirement and KKDC to offer the suitable option

### LED ENGINE VARIANTS (LED STRIP TYPE)

Colour	LED	Lumen/m	Lumen/ft	W/m	W/ft	Spec Doc	Length	Increment
Single CCT	R007	490	149	7	2.13	MIMI SL R007	99-2016mm (3.89-79.37in)	41.7mm (1.64in)
	R014	1024	312	14	4.27	MIMI SL R014	99-2016mm (3.89-79.37in)	41.7mm (1.64in)
	R020	1463	446	20	6.1	MIMI SL R020	99-2016mm (3.89-79.37in)	41.7mm (1.64in)
RGB	501	Red 113 Green 224 Blue 40 RGB 353	Red 34 Green 68 Blue 12 RGB 108	15.6	4.75	MIMI SL RGB	99-2016mm (3.89-79.37in)	83.3mm (3.28in)

\* Performance data: s-line, silicone potted, 3000K

# MIMI SL R020

## Length Availability List



Length Code		Fixture Length <sup>1</sup>		LED Strip <sup>2</sup>		End Cap Dimension		Wattage (W)	Output (lm)
Metric	Imperial(US)	Metric	Imperial(US)	Metric	Imperial(US)	Metric	Imperial(US)		3000K (Test Data)
m0099	i0004	99mm	3.91in	83mm	3.28in	2.4mm	0.09in	1.67	122
m0141	i0006	141mm	5.55in	125mm	4.92in	2.4mm	0.09in	2.50	183
m0183	i0007	183mm	7.19in	167mm	6.56in	2.4mm	0.09in	3.33	244
m0224	i0009	224mm	8.83in	208mm	8.20in	2.4mm	0.09in	4.17	305
m0266	i0010	266mm	10.47in	250mm	9.84in	2.4mm	0.09in	5.00	365
m0308	i0012	308mm	12.11in	292mm	11.48in	2.4mm	0.09in	5.83	426
m0349	i0014	349mm	13.75in	333mm	13.12in	2.4mm	0.09in	6.67	487
m0391	i0015	391mm	15.39in	375mm	14.76in	2.4mm	0.09in	7.50	548
m0433	i0017	433mm	17.03in	417mm	16.40in	2.4mm	0.09in	8.33	609
m0474	i0019	474mm	18.67in	458mm	18.04in	2.4mm	0.09in	9.17	670
m0516	i0020	516mm	20.31in	500mm	19.69in	2.4mm	0.09in	10.00	731
m0558	i0022	558mm	21.96in	542mm	21.33in	2.4mm	0.09in	10.83	792
m0599	i0024	599mm	23.60in	583mm	22.97in	2.4mm	0.09in	11.67	853
m0641	i0025	641mm	25.24in	625mm	24.61in	2.4mm	0.09in	12.50	914
m0683	i0027	683mm	26.88in	667mm	26.25in	2.4mm	0.09in	13.33	975
m0724	i0029	724mm	28.52in	708mm	27.89in	2.4mm	0.09in	14.17	1036
m0766	i0030	766mm	30.16in	750mm	29.53in	2.4mm	0.09in	15.00	1096
m0808	i0032	808mm	31.80in	792mm	31.17in	2.4mm	0.09in	15.83	1157
m0849	i0033	849mm	33.44in	833mm	32.81in	2.4mm	0.09in	16.67	1218
m0891	i0035	891mm	35.08in	875mm	34.45in	2.4mm	0.09in	17.50	1279
m0933	i0037	933mm	36.72in	917mm	36.09in	2.4mm	0.09in	18.33	1340
m0974	i0038	974mm	38.36in	958mm	37.73in	2.4mm	0.09in	19.17	1401
m1016	i0040	1016mm	40.00in	1000mm	39.37in	2.4mm	0.09in	20.00	1462
m1058	i0042	1058mm	41.64in	1042mm	41.01in	2.4mm	0.09in	20.83	1523
m1099	i0043	1099mm	43.28in	1083mm	42.65in	2.4mm	0.09in	21.67	1584
m1141	i0045	1141mm	44.92in	1125mm	44.29in	2.4mm	0.09in	22.50	1645
m1183	i0047	1183mm	46.56in	1167mm	45.93in	2.4mm	0.09in	23.33	1706
m1224	i0048	1224mm	48.20in	1208mm	47.57in	2.4mm	0.09in	24.17	1767
m1266	i0050	1266mm	49.84in	1250mm	49.21in	2.4mm	0.09in	25.00	1827
m1308	i0051	1308mm	51.48in	1292mm	50.85in	2.4mm	0.09in	25.83	1888
m1349	i0053	1349mm	53.12in	1333mm	52.49in	2.4mm	0.09in	26.67	1949
m1391	i0055	1391mm	54.76in	1375mm	54.13in	2.4mm	0.09in	27.50	2010
m1433	i0056	1433mm	56.40in	1417mm	55.77in	2.4mm	0.09in	28.33	2071
m1474	i0058	1474mm	58.04in	1458mm	57.41in	2.4mm	0.09in	29.17	2132
m1516	i0060	1516mm	59.69in	1500mm	59.06in	2.4mm	0.09in	30.00	2193
m1558	i0061	1558mm	61.33in	1542mm	60.70in	2.4mm	0.09in	30.83	2254
m1599	i0063	1599mm	62.97in	1583mm	62.34in	2.4mm	0.09in	31.67	2315
m1641	i0065	1641mm	64.61in	1625mm	63.98in	2.4mm	0.09in	32.50	2376
m1683	i0066	1683mm	66.25in	1667mm	65.62in	2.4mm	0.09in	33.33	2437
m1724	i0068	1724mm	67.89in	1708mm	67.26in	2.4mm	0.09in	34.17	2498
m1766	i0070	1766mm	69.53in	1750mm	68.90in	2.4mm	0.09in	35.00	2558
m1808	i0071	1808mm	71.17in	1792mm	70.54in	2.4mm	0.09in	35.83	2619
m1849	i0073	1849mm	72.81in	1833mm	72.18in	2.4mm	0.09in	36.67	2680

# MIMI SL R020

## Length Availability List



Length Code		Fixture Length <sup>1</sup>		LED Strip <sup>2</sup>		End Cap Dimension		Wattage (W)	Output (lm) 3000K (Test Data)
Metric	Imperial(US)	Metric	Imperial(US)	Metric	Imperial(US)	Metric	Imperial(US)		
m1891	i0074	1891mm	74.45in	1875mm	73.82in	2.4mm	0.09in	37.50	2741
m1933	i0076	1933mm	76.09in	1917mm	75.46in	2.4mm	0.09in	38.33	2802
m1974	i0078	1974mm	77.73in	1958mm	77.10in	2.4mm	0.09in	39.17	2863
m2016	i0079	2016mm	79.37in	2000mm	78.74in	2.4mm	0.09in	40.00	2924

<sup>1</sup> Actual total overall length of light fixture (LED strip + end caps + void/wire hole)

<sup>2</sup> Actual length of PCB strip

<sup>3</sup> Actual length of 2x end caps

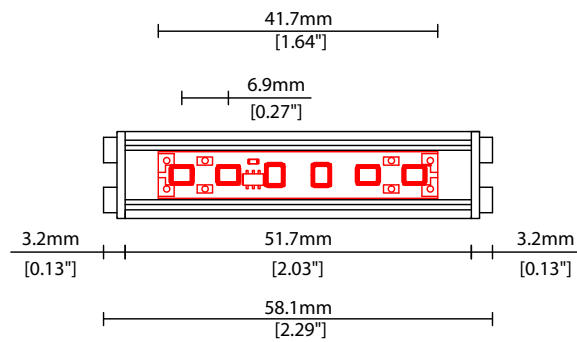

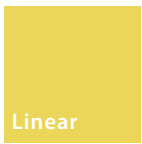

# MIMI SL R020

## Options



### COVER/LENS OPTIONS

\* Options are an integral part of the fixture ordering codes. Please refer to **Code Table** pages.

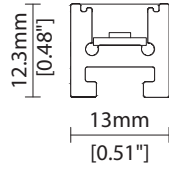

No cover (Silicone potted)  
W19.5/H38.1mm (W0.77"/H1.50")

### POWER FEED OPTIONS

\* Options are an integral part of the fixture ordering codes. Please refer to **Code Table** pages.

**0300 S00A 300mm (11.81") Single ø4.3mm sheath tail**

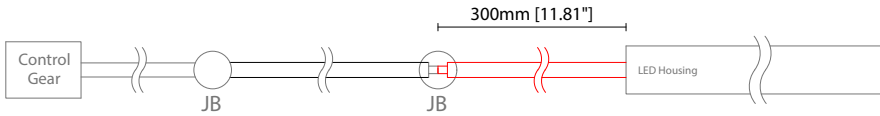

**0300 D00A 300mm (11.81") Double ø4.3mm sheath tail**

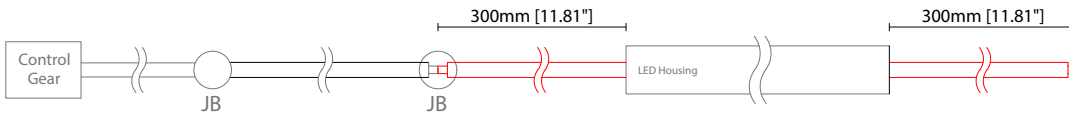

**0300 S67A 300mm (11.81") Single ø4.3mm sheath IP67 connector**

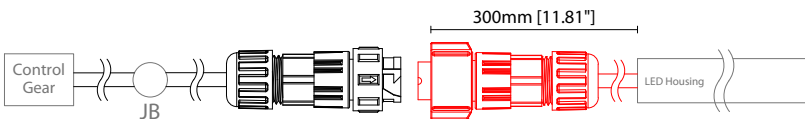

**0300 D67A 300mm (11.81") Double ø4.3mm sheath IP67 connector**

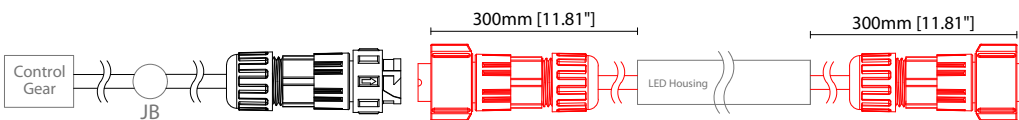

### IP67 2 Pin Connector

Female connector  
2 PIN (IP67)

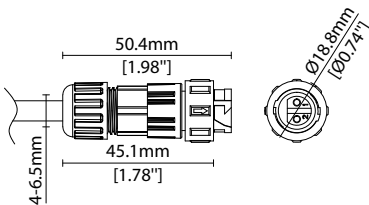

Male connector  
2 PIN (IP67)

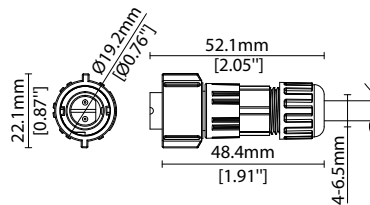

### Key

- Control Gear Power supply, sub-controllers & control systems
- JB Junction box / cable connection

### MOUNTING ACCESSORIES

Note: Accessories are to be ordered separately with corresponding code shown below.



**KKCP-02** (1no.)  
**KKCP-52** (500no.)  
 Clip (allow 3 per metre/40in)  
 S/Steel finish  
 L25/W16.7/H13.5mm  
 (L0.98/W0.66/H0.53")

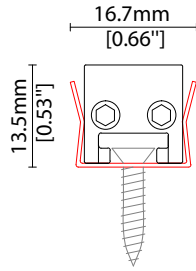

**KKBK-06**  
 Fixed bracket (allow 3 per metre/40in)  
 S/Steel finish  
 L20/W29.1/H26.7mm  
 (0.79/W1.15/H1.05")

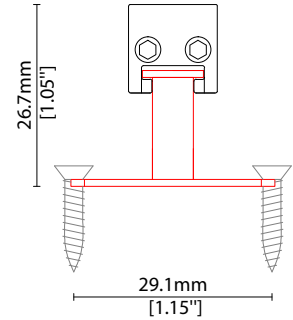

**KKBK-05**  
 Adjustable bracket  
 (allow 2 per metre/40in)  
 S/Steel finish  
 L36.5/W13/H30.9mm  
 (L1.44/W0.51/H1.22")

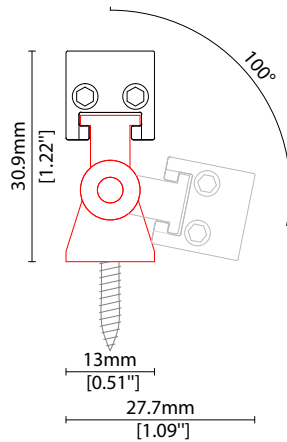

### POWER FEED

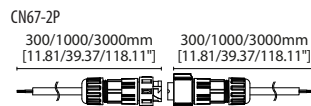

**CN67-2P-0300** 300mm (11.81in) pair  
**CN67-2P-1000** 1000mm (39.37in) pair  
**CN67-2P-3000** 3000mm (118.11in) pair  
 IP67  
 2 PIN male + female connector set



### EXTERIOR JUNCTION BOXES



**KKJB-07**

IP67 Slim J-Box  
(including type A,B,C,D bushings)



**KKJB-07R**

Potting resin for IP67 Slim J-Box

### KKDC CONTROL



**KKDM-06** 1-10V

visDIM dimmable sub-controller  
(4 x 8A max @ 12-36V)

IP20  
Plastic housing  
L170/W59/H29mm  
(L6.69/W2.32/H1.14in)



**KKSC-05** DMX

visDIM dimmable sub-controller  
(4 x 5A max @ 12-36V)

IP20  
Plastic housing  
L170/W53.4/H28mm  
(L6.69/W2.10/H1.10in)



**KKDL-02** DALI

visDIM dimmable sub-controller  
(4 x 8A max @ 12-36V)

IP20  
Plastic housing  
L170/W59/H29mm  
(L6.69/W2.32/H1.14in)



**KKDL-03** DALI

visDIM dimmable sub-controller  
(4 x 5A max @ 12-36V)

IP20  
Plastic housing  
L166/W53.4/H23mm  
(L6.54/W2.10/H0.91in)

### AVAILABLE PSU OPTIONS

Control Mode	PSU (Order Code)	Input Voltage AC	Output Voltage DC	Rated Output Current	Rated Power	Dim %	IP Rating
Switched	CEN-60-24	90-295V	24V	2.5A	60W	-	IP67
	HLG-60H-24	90-305V	24V	2.5A	60W	-	IP67
	HLG-100H-24	90-305V	24V	4.0A	100W	-	IP67
	HLG-150H-24	90-305V	24V	6.3A	150W	-	IP67
	HLG-240H-24	90-305V	24V	10A	240W	-	IP67
0-10V (1-10V)	PWM-40-24	90-305V	24V	1.67A	40W	100-0.15 (100-10)	IP67
	PWM-60-24	90-305V	24V	2.5A	60W	100-0.15 (100-10)	IP67
	PWM-90-24	90-305V	24V	3.67A	90W	100-0.15 (100-10)	IP67
	PWM-120-24	90-305V	24V	5.0A	120W	100-0.15 (100-10)	IP67
DALI	LIN100A1	120-277V	24V	1A per channel	100W	100-0.1	IP66/IP40
DMX RGB	LIN100A1	120-277V	24V	1.33A per channel	100W	100-0.1	IP66/IP40
DMX RGBW	LIN100A1	120-277A	24V	1A per channel	100W	100-0.1	IP66/IP40

### Flicker Free Options - Combination of PSU+ sub-controller

Control Mode	PSU (Order Code)	Sub-controller (Order Code)	Input Voltage AC	Output Voltage DC	Rated Output Current	Rated Power	Dim %	IP Rating PSU/ Sub-controller
0-10V or 1-10V	CEN-60-24	KKDM-06	90-295V	24V	2.5A	60W	100-0.9	IP67/IP20
	HLG-60H-24	KKDM-06	90-295V	24V	2.5A	60W	100-0.9	IP67/IP20
	HLG-100H-24	KKDM-06	90-295V	24V	4.0A	100W	100-0.9	IP67/IP20
	HLG-150H-24	KKDM-06	90-295V	24V	6.3A	150W	100-0.9	IP67/IP20
	HLG-240H-24	KKDM-06	90-295V	24V	10.0A	240W	100-0.9	IP67/IP20
DALI	CEN-60-24	KKDL-02/03	90-295V	24V	2.5A	60W	100-0.1	IP67/IP20
	HLG-60H-24	KKDL-02/03	90-305V	24V	2.5A	60W	100-0.1	IP67/IP20
	HLG-100H-24	KKDL-02/03	90-305V	24V	4.0A	100W	100-0.1	IP67/IP20
	HLG-150H-24	KKDL-02/03	90-305V	24V	6.3A	150W	100-0.1	IP67/IP20
	HLG-240H-24	KKDL-02/03	90-305V	24V	10.0A	240W	100-0.1	IP67/IP20
DMX RGB	CEN-60-24	KKSC-05	90-295V	24V	2.5A	60W	100-0.9	IP67/IP20
	HLG-60H-24	KKSC-05	90-305V	24V	2.5A	60W	100-0.9	IP67/IP20
	HLG-100H-24	KKSC-05	90-305V	24V	4A	100W	100-0.9	IP67/IP20
	HLG-150H-24	KKSC-05	90-305V	24V	6.3A	150W	100-0.9	IP67/IP20
	HLG-240H-24	KKSC-05	90-305V	24V	10.0A	240W	100-0.9	IP67/IP20

<sup>1</sup> The items shown above cover the most frequently used specification but does not exhaust the possible options

<sup>2</sup> PSU and/or driver can be chosen from the table, or KKDC may recommend the best option upon receipt of the controls requirement and installation environment

<sup>3</sup> Electrical shop drawing will include detailed information of PSU and relevant control drivers

<sup>4</sup> Cut sheets are available on the controls section of [www.kkdc.lighting](http://www.kkdc.lighting) or upon request